

接觸角滾珠軸承

70、72、73型號

A. 接觸角 30°

B. 接觸角 44°

C. 接觸角 15°



接觸角滾珠軸承

內徑 10~17mm

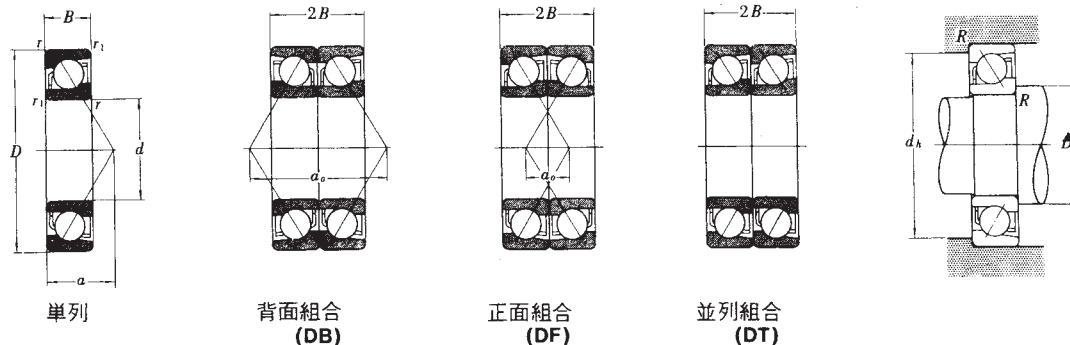

d	主要寸法(mm)				(1) 基本定格荷重(kgf)			極限速率(rpm)		作用点位置 (mm) a	接觸角和倒角尺寸(mm)			重量(kg) (参考) (單列)
	D	B	r	r ₁	基本型號	C	Co	脂潤滑	油潤滑		D _s (最小)	d _h (最大)	R (最大)	
10	26	8	0.5	0.3	7000 A	395	224	24000	32000	9.2	12.5	23.5	0.3	0.020
	26	8	0.5	0.3	7000 B	365	201	22000	30000	11.6	12.5	23.5	0.3	0.020
	26	8	0.5	0.3	7000 C	415	245	41000	56000	6.4	12.5	23.5	0.3	0.019
	30	9	1	0.5	7200 A	425	253	22000	30000	10.3	15	25	0.6	0.031
	30	9	1	0.5	7200 B	390	226	20000	28000	12.9	15	25	0.6	0.031
	30	9	1	0.5	7200 C	425	250	36000	50000	7.2	15	25	0.6	0.030
	35	11	1	0.5	7300 A	730	435	20000	26000	12.0	15	30	0.6	0.054
	35	11	1	0.5	7300 B	685	390	18000	24000	14.9	15	30	0.6	0.054
	35	11	1	0.5	7300 C	760	475	32000	44000	8.5	15	30	0.6	0.052
12	28	8	0.5	0.3	7001 A	425	252	22000	30000	9.8	14.5	25.5	0.3	0.022
	28	8	0.5	0.3	7001 B	390	226	20000	28000	12.4	14.5	25.5	0.3	0.022
	28	8	0.5	0.3	7001 C	455	275	37000	50000	6.7	14.5	25.5	0.3	0.021
	32	10	1	0.5	7201 A	630	385	20000	27000	11.4	17	27	0.6	0.038
	32	10	1	0.5	7201 B	585	350	18000	24000	14.2	17	27	0.6	0.038
	32	10	1	0.5	7201 C	620	380	34000	45000	7.9	17	27	0.6	0.037
	37	12	1.5	0.8	7301 A	725	430	18000	24000	13.1	18	31	1	0.064
	37	12	1.5	0.8	7301 B	695	400	16000	22000	16.3	18	31	1	0.064
	37	12	1.5	0.8	7301 C	780	480	30000	40000	9.3	18	31	1	0.061
15	32	9	0.5	0.3	7002 A	450	283	19000	24000	11.3	17.5	29.5	0.3	0.031
	32	9	0.5	0.3	7002 B	410	253	17000	23000	14.4	17.5	29.5	0.3	0.031
	32	9	0.5	0.3	7002 C	490	310	32000	43000	7.6	17.5	29.5	0.3	0.030
	35	11	1	0.5	7202 A	675	435	18000	24000	12.8	20	30	0.6	0.048
	35	11	1	0.5	7202 B	620	390	16000	22000	16.0	20	30	0.6	0.048
	35	11	1	0.5	7202 C	680	435	30000	40000	8.8	20	30	0.6	0.046
	42	13	1.5	0.8	7302 A	1050	685	16000	21000	14.7	21	36	1	0.087
	42	13	1.5	0.8	7302 B	975	615	14000	19000	18.5	21	36	1	0.087
	42	13	1.5	0.8	7302 C	1030	675	26000	35000	10.3	21	36	1	0.083
17	35	10	0.5	0.3	7003 A	480	310	17000	22000	12.5	19.5	32.5	0.3	0.041
	35	10	0.5	0.3	7003 B	435	279	15000	21000	15.9	19.5	32.5	0.3	0.041
	35	10	0.5	0.3	7003 C	520	345	28000	38000	8.5	19.5	32.5	0.3	0.039
	40	12	1	0.5	7203 A	845	560	16000	21000	14.3	22	35	0.6	0.070
	40	12	1	0.5	7203 B	795	500	14000	19000	17.9	22	35	0.6	0.070
	40	12	1	0.5	7203 C	855	555	26000	35000	9.8	22	35	0.6	0.066
	47	14	1.5	0.8	7303 A	1250	830	14000	19000	16.3	23	41	1	0.120
	47	14	1.5	0.8	7303 B	1160	750	13000	17000	20.4	23	41	1	0.120
	47	14	1.5	0.8	7303 C	1240	820	22000	31000	11.3	23	41	1	0.112

接觸角滾珠軸承

內徑 20~35 mm

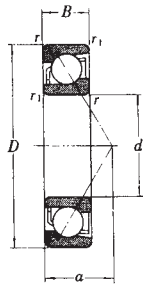

單列

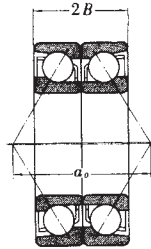

背面組合
(DB)

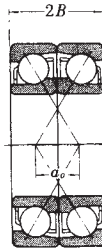

正面組合
(DF)



並列組合
(DT)

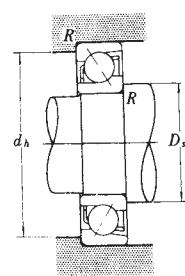

主要寸法(mm)					(1) 基本定格荷重(kgf)		極限速率(rpm)		作用点位置 (mm) a	接觸面和倒角尺寸(mm)			重量(kg) (参考) (單列)	
d	D	B	r	r ₁	基本型號	C	C ₀	脂潤滑		油潤滑	D _s (最小)	d _h (最大)		R (最大)
20	42	12	1	0.5	7004 A	805	550	15000	19000	14.9	25	37	0.6	0.072
	42	12	1	0.5	7004 B	735	490	13000	18000	19.0	25	37	0.6	0.072
	42	12	1	0.5	7004 C	870	605	24000	32000	10.2	25	37	0.6	0.068
	47	14	1.5	0.8	7204 A	1140	770	13000	18000	16.7	26	41	1	0.110
	47	14	1.5	0.8	7204 B	1040	690	12000	16000	21.0	26	41	1	0.110
	47	14	1.5	0.8	7204 C	1140	770	22000	30000	11.5	26	41	1	0.105
	52	15	2	1	7304 A	1470	995	13000	17000	18.0	27	45	1	0.150
	52	15	2	1	7304 B	1370	895	11000	15000	22.5	27	45	1	0.150
	52	15	2	1	7304 C	1450	980	20000	28000	12.3	27	45	1	0.144
25	47	12	1	0.5	7005 A	845	600	13000	17000	16.4	30	42	0.6	0.083
	47	12	1	0.5	7005 B	765	540	11000	15000	21.1	30	42	0.6	0.083
	47	12	1	0.5	7005 C	915	665	20000	28000	10.8	30	42	0.6	0.079
	52	15	1.5	0.8	7205 A	1280	930	12000	15000	18.7	31	46	1	0.135
	52	15	1.5	0.8	7205 B	1160	830	10000	14000	23.6	31	46	1	0.135
	52	15	1.5	0.8	7205 C	1300	945	19000	26000	12.7	31	46	1	0.130
	62	17	2	1	7305 A	2060	1500	10000	14000	21.2	32	55	1	0.245
	62	17	2	1	7305 B	1910	1340	9000	12000	26.7	32	55	1	0.245
	62	17	2	1	7305 C	2070	1490	17000	23000	14.3	32	55	1	0.228
30	55	13	1.5	0.8	7006 A	1090	825	11000	14000	18.8	36	49	1	0.120
	55	13	1.5	0.8	7006 B	985	735	9500	13000	24.3	36	49	1	0.120
	55	13	1.5	0.8	7006 C	1190	910	17000	24000	12.2	36	49	1	0.115
	62	16	1.5	0.8	7206 A	1770	1330	10000	13000	21.4	36	56	1	0.210
	62	16	1.5	0.8	7206 B	1610	1190	8500	12000	27.2	36	56	1	0.210
	62	16	1.5	0.8	7206 C	1810	1360	16000	22000	14.2	36	56	1	0.196
	72	19	2	1	7306 A	2630	1960	9000	12000	24.3	37	65	1	0.360
	72	19	2	1	7306 B	2410	1800	8000	11000	30.8	37	65	1	0.360
	72	19	2	1	7306 C	2640	1960	14000	20000	16.3	37	65	1	0.340
35	62	14	1.5	0.8	7007 A	1370	1090	9500	12000	21.0	41	56	1	0.160
	62	14	1.5	0.8	7007 B	1240	975	8000	11000	27.3	41	56	1	0.160
	62	14	1.5	0.8	7007 C	1500	1210	15000	20000	13.5	41	56	1	0.153
	72	17	2	1	7207 A	2330	1820	8500	11000	24.0	42	65	1	0.295
	72	17	2	1	7207 B	2130	1620	7500	10000	30.9	42	65	1	0.295
	72	17	2	1	7207 C	2380	1850	14000	19000	15.7	42	65	1	0.280
	80	21	2.5	1.2	7307 A	3150	2440	8000	10000	27.2	43.5	71.5	1.5	0.475
	80	21	2.5	1.2	7307 B	2880	2190	7100	9500	34.5	43.5	71.5	1.5	0.475
	80	21	2.5	1.2	7307 C	3150	2450	13000	17000	18.2	43.5	71.5	1.5	0.455

接觸角滾珠軸承

內徑 40~55mm

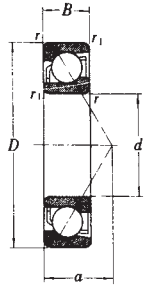

單列

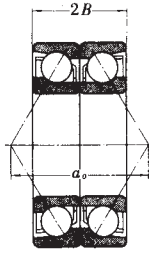

背面組合
(DB)

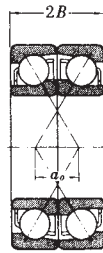

正面組合
(DF)

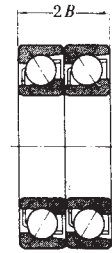

並列組合
(DT)

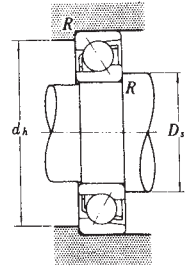

d	主要寸法(mm)				基本型號	(1) 基本定格荷重(kgf)		極限速率(rpm)		作用點位置 (mm) a	接觸角和倒角尺寸(mm)			重量(kg) (參考) (單列)
	D	B	r	r ₁		C	Co	脂潤滑	油潤滑		D _s (最小)	d _h (最大)	R (最大)	
40	68	15	1.5	0.8	7008 A	1470	1250	8500	11000	23.1	46	62	1	0.198
	68	15	1.5	0.8	7008 B	1320	1110	7500	10000	30.2	46	62	1	0.198
	68	15	1.5	0.8	7008 C	1610	1380	13000	18000	14.7	46	62	1	0.189
	80	18	2	1	7208 A	2770	2260	7500	10000	26.4	47	73	1	0.380
	80	18	2	1	7208 B	2520	2020	6700	9000	34.1	47	73	1	0.380
	80	18	2	1	7208 C	2850	2310	12000	17000	17.0	47	73	1	0.360
	90	23	2.5	1.2	7308 A	3800	3050	7100	9000	30.4	48.5	81.5	1.5	0.660
	90	23	2.5	1.2	7308 B	3500	2740	6300	8500	38.7	48.5	81.5	1.5	0.660
	90	23	2.5	1.2	7308 C	3850	3050	11000	15000	20.2	48.5	81.5	1.5	0.620
45	75	16	1.5	0.8	7009 A	1740	1510	7500	10000	25.3	51	69	1	0.250
	75	16	1.5	0.8	7009 B	1570	1350	6700	9000	33.2	51	69	1	0.250
	75	16	1.5	0.8	7009 C	1910	1670	12000	16000	16.0	51	69	1	0.240
	85	19	2	1	7209 A	3100	2570	7100	9000	28.4	52	78	1	0.430
	85	19	2	1	7209 B	2830	2300	6300	8500	36.7	52	78	1	0.430
	85	19	2	1	7209 C	3200	2630	11000	15000	18.2	52	78	1	0.410
	100	25	2.5	1.2	7309 A	4950	4100	6300	8500	33.6	53.5	91.5	1.5	0.875
	100	25	2.5	1.2	7309 B	4600	3500	5600	7500	42.8	53.5	91.5	1.5	0.875
	100	25	2.5	1.2	7309 C	5000	4100	10000	14000	22.2	53.5	91.5	1.5	0.830
50	80	16	1.5	0.8	7010 A	1850	1700	7100	9000	26.8	56	74	1	0.272
	80	16	1.5	0.8	7010 B	1660	1520	6300	8500	35.3	56	74	1	0.272
	80	16	1.5	0.8	7010 C	2040	1880	11000	15000	16.7	56	74	1	0.260
	90	20	2	1	7210 A	3250	2780	6300	8500	30.3	57	83	1	0.485
	90	20	2	1	7210 B	2930	2450	5600	8000	39.3	57	83	1	0.485
	90	20	2	1	7210 C	3350	2860	10000	14000	19.4	57	83	1	0.465
	110	27	3	1.5	7310 A	5800	4850	5600	7500	36.8	60	100	2	1.150
	110	27	3	1.5	7310 B	5400	4350	5000	6700	46.9	60	100	2	1.150
	110	27	3	1.5	7310 C	5850	4900	9000	13000	24.2	60	100	2	1.080
55	90	18	2	1	7011 A	2440	2240	6300	8500	29.9	62	83	1	0.400
	90	18	2	1	7011 B	2190	2000	5600	7500	39.4	62	83	1	0.400
	90	18	2	1	7011 C	2670	2480	10000	14000	18.7	62	83	1	0.380
	100	21	2.5	1.2	7211 A	4000	3500	6000	7500	33.0	63.5	91.5	1.5	0.635
	100	21	2.5	1.2	7211 B	3600	3150	5300	7100	42.9	63.5	91.5	1.5	0.635
	100	21	2.5	1.2	7211 C	4150	3600	9500	13000	20.9	63.5	91.5	1.5	0.610
	120	29	3	1.5	7311 A	6300	5200	5000	7000	40.0	65	110	2	1.60
	120	29	3	1.5	7311 B	5800	4700	4500	6300	51.9	65	110	2	1.60
	120	29	3	1.5	7311 C	6750	5750	8500	11000	26.2	65	110	2	1.37

接觸角滾珠軸承

內徑 60~75mm

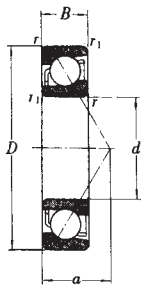

單列

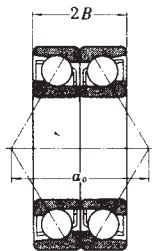

背面組合
(DB)



正面組合
(DF)



並列組合
(DT)

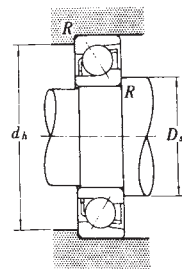

主要寸法(mm)					(1) 基本定格荷重(kgf)			極限速率(rpm)		作用点位置 (mm) a	接觸面和倒角尺寸(mm)			重量(kg) (参考) (單列)
d	D	B	r	r ₁	基本型號	C	Co	脂潤滑	油潤滑		D _s (最小)	d _h (最大)	R (最大)	
60	95	18	2	1	7012 A	2500	2370	6000	7500	31.4	67	88	1	0.425
	95	18	2	1	7012 B	2240	2120	5300	7100	41.5	67	88	1	0.425
	95	18	2	1	7012 C	2750	2630	9500	13000	19.4	67	88	1	0.405
	110	22	2.5	1.2	7212 A	4850	4300	5300	7100	35.7	68.5	101.5	1.5	0.820
	110	22	2.5	1.2	7212 B	4400	3850	4800	6300	46.6	68.5	101.5	1.5	0.820
	110	22	2.5	1.2	7212 C	5050	4450	8500	12000	22.4	68.5	101.5	1.5	0.780
	130	31	3.5	2	7312 A	7200	6050	4800	6300	43.1	72	118	2	2.00
	130	31	3.5	2	7312 B	6650	5450	4300	5600	55.2	72	118	2	2.00
	130	31	3.5	2	7312 C	7750	6650	7500	10000	28.2	72	118	2	1.72
65	100	18	2	1	7013 A	2640	2630	5600	7100	32.8	72	93	1	0.455
	100	18	2	1	7013 B	2370	2350	4800	6700	43.6	72	93	1	0.455
	100	18	2	1	7013 C	2910	2920	9000	12000	20.0	72	93	1	0.435
	120	23	2.5	1.2	7213 A	5500	5100	4800	6500	38.4	73.5	111.5	1.5	1.00
	120	23	2.5	1.2	7213 B	5000	4600	4300	6000	50.2	73.5	111.5	1.5	1.00
	120	23	2.5	1.2	7213 C	5750	5300	8000	11000	23.9	73.5	111.5	1.5	0.975
	140	33	3.5	2	7313 A	8200	6950	4300	5800	46.3	77	128	2	2.47
	140	33	3.5	2	7313 B	7500	6250	4000	5300	59.4	77	128	2	2.47
	140	33	3.5	2	7313 C	8750	7650	7100	9500	30.2	77	128	2	2.12
70	110	20	2	1	7014 A	3350	3350	5000	6700	36.0	77	103	1	0.625
	110	20	2	1	7014 B	3000	2970	4500	6000	47.8	77	103	1	0.625
	110	20	2	1	7014 C	3700	3700	8000	11000	22.0	77	103	1	0.600
	125	24	2.5	1.2	7214 A	6000	5600	4500	6300	40.3	78.5	116.5	1.5	1.10
	125	24	2.5	1.2	7214 B	5400	5000	4100	5600	52.8	78.5	116.5	1.5	1.10
	125	24	2.5	1.2	7214 C	6250	5800	7500	10000	25.1	78.5	116.5	1.5	0.07
	150	35	3.5	2	7314 A	9200	7950	4000	5300	49.5	82	138	2	3.00
	150	35	3.5	2	7314 B	8450	7100	3600	5000	63.5	82	138	2	3.00
	150	35	3.5	2	7314 C	9850	8700	6700	9000	32.2	82	138	2	2.57
75	115	20	2	1	7015 A	3400	3500	4800	6300	37.4	82	108	1	0.660
	115	20	2	1	7015 B	3050	3150	4300	5600	49.9	82	108	1	0.660
	115	20	2	1	7015 C	3750	3900	7500	10000	22.7	82	108	1	0.630
	130	25	2.5	1.2	7215 A	5950	5650	4300	5800	42.3	83.5	121.5	1.5	1.37
	130	25	2.5	1.2	7215 B	5400	5000	4000	5300	55.4	83.5	121.5	1.5	1.37
	130	25	2.5	1.2	7215 C	6500	6200	7100	9500	26.2	83.5	121.5	1.5	1.17
	160	37	3.5	2	7315 A	10000	8950	3800	5000	52.7	87	148	2	3.60
	160	37	3.5	2	7315 B	9200	8050	3400	4800	67.6	87	148	2	3.60
	160	37	3.5	2	7315 C	10700	9850	6300	8500	34.2	87	148	2	3.10

接觸角滾珠軸承

內徑 80~95 mm

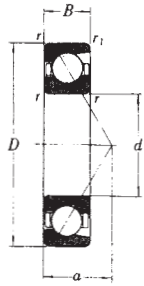

單列

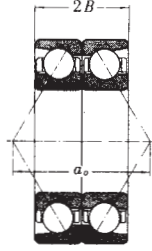

背面組合
(DB)

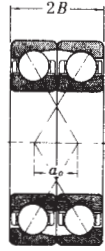

正面組合
(DF)



並列組合
(DT)

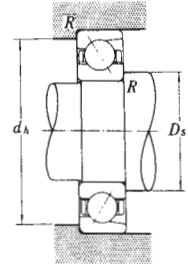

主要寸法(mm)					(1) 基本定格荷重(kgf)		極限速率(rpm)		作用点位置 (mm) a	接觸角和倒角尺寸(mm)			重量(kg) (参考) (單列)	
d	D	B	r	r ₁	基本型號	C	Co	脂潤滑		油潤滑	Ds (最小)	dh (最大)		R (最大)
80	125	22	2	1	7016 A	4200	4300	4300	6000	40.6	87	118	1	0.88
	125	22	2	1	7016 B	3750	3800	3800	5300	54.0	87	118	1	0.88
	125	22	2	1	7016 C	4600	4750	7100	9500	24.7	87	118	1	0.84
	140	26	3	1.5	7216 A	6700	6250	4000	5400	44.9	90	130	2	1.67
	140	26	3	1.5	7216 B	6050	5600	3600	5000	59.0	90	130	2	1.67
	140	26	3	1.5	7216 C	7300	6900	6700	9000	27.7	90	130	2	1.43
	170	39	3.5	2	7316 A	10800	10000	3600	4800	55.9	92	158	2	4.25
	170	39	3.5	2	7316 B	9950	9000	3200	4300	71.8	92	158	2	4.25
	170	39	3.5	2	7316 C	11600	11000	6000	8000	36.2	92	158	2	3.65
85	130	22	2	1	7017 A	4300	4500	4300	5600	42.0	92	123	1	0.925
	130	22	2	1	7017 B	3850	4000	3600	5000	56.1	92	123	1	0.925
	130	22	2	1	7017 C	4700	5000	6700	9000	25.4	92	123	1	0.885
	150	28	3	1.5	7217 A	7750	7350	3800	5000	48.1	95	140	2	2.08
	150	28	3	1.5	7217 B	7000	6550	3400	4500	63.0	95	140	2	2.08
	150	28	3	1.5	7217 C	8400	8100	6300	8500	29.7	95	140	2	1.78
	180	41	4	2	7317 A	11700	11200	3400	4500	59.0	99	166	2.5	5.05
	180	41	4	2	7317 B	10900	10000	3000	4000	75.9	99	166	2.5	5.05
	180	41	4	2	7317 C	12500	12300	5300	7500	38.2	99	166	2.5	4.30
90	140	24	2.5	1.2	7018 A	5100	5350	3800	5300	45.2	98.5	131.5	1.5	1.20
	140	24	2.5	1.2	7018 B	4600	4750	3400	4800	60.2	98.5	131.5	1.5	1.20
	140	24	2.5	1.2	7018 C	5600	5900	6300	8500	27.4	98.5	131.5	1.5	1.15
	160	30	3	1.5	7218 A	8800	8500	3600	4800	51.3	100	150	2	2.55
	160	30	3	1.5	7218 B	8000	7600	3200	4300	67.3	100	150	2	2.55
	160	30	3	1.5	7218 C	9600	9400	5800	8000	31.7	100	150	2	2.18
	190	43	4	2	7318 A	12600	12400	3200	4300	62.2	104	176	3.5	5.85
	190	43	4	2	7318 B	11500	11100	2800	3800	80.0	104	176	2.5	5.85
	190	43	4	2	7318 C	13500	13700	5000	7100	40.2	104	176	2.5	5.00
95	145	24	2.5	1.2	7019 A	5250	5650	3800	5000	46.6	103.5	136.5	1.5	1.40
	145	24	2.5	1.2	7019 B	4700	5000	3200	4500	62.3	103.5	136.5	1.5	1.40
	145	24	2.5	1.2	7019 C	5750	6250	6000	8000	28.1	103.5	136.6	1.5	1.20
	170	32	3.5	2	7219 A	9600	9100	3400	4500	54.5	107	158	2	3.10
	170	32	3.5	2	7219 B	8700	8150	3000	4000	71.4	107	158	2	3.10
	170	32	3.5	2	7219 C	10400	10100	5400	7500	33.7	107	158	2	2.65
	200	45	4	2	7319 A	13500	13700	3000	4000	65.4	109	186	2.5	6.75
	200	45	4	2	7319 B	12300	12300	2600	3600	84.2	109	186	2.5	6.75
	200	45	4	2	7319 C	14400	15000	5000	6700	42.2	109	186	2.5	5.80

接觸角滾珠軸承

內徑100~120mm

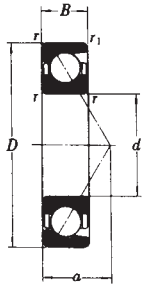

單列

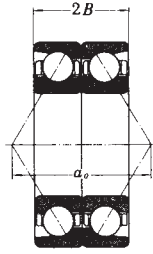

背面組合
(DB)

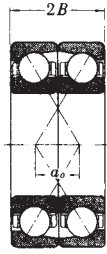

正面組合
(DF)



並列組合
(DT)

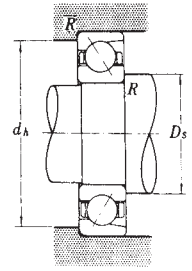

d	主要寸法(mm)				(1) 基本定格荷重(kgf)			極限速率(rpm)		作用点位置(mm) a	接觸角和倒角尺寸(mm)			重量(kg) (参考) (单列)
	D	B	r	r ₁	基本型號	C	Co	脂潤滑	油潤滑		D _s (最小)	d _h (最大)	R (最大)	
100	150	24	2.5	1.2	7020 A	5350	5900	3600	4800	48.1	108.5	141.5	1.5	1.46
	150	24	2.5	1.2	7020 B	4800	5250	3200	4300	64.4	108.5	141.5	1.5	1.46
	150	24	2.5	1.2	7020 C	5900	6550	5600	8000	28.7	108.5	141.5	1.5	1.25
	180	34	3.5	2	7220 A	10800	10400	3200	4300	57.7	112	168	2	3.70
	180	34	3.5	2	7220 B	9750	9250	2800	3800	75.6	112	168	2	3.70
	180	34	3.5	2	7220 C	11700	11400	5100	7100	35.7	112	168	2	3.15
	215	47	4	2	7320 A	16300	17800	2800	3800	69.3	114	201	2.5	8.30
215	47	4	2	7320 B	14900	16000	2400	3400	89.4	114	201	2.5	8.30	
215	47	4	2	7320 C	17400	19600	4500	6300	44.6	114	201	2.5	7.10	
105	160	26	3	1.5	7021 A	6250	6900	3400	4500	51.2	115	150	2	1.85
	160	26	3	1.5	7021 B	5600	6150	3000	4000	68.6	115	150	2	1.85
	160	26	3	1.5	7021 C	6900	7600	5300	7500	30.7	115	150	2	1.58
	190	36	3.5	2	7221 A	11700	11700	3000	4000	60.8	117	178	2	4.40
	190	36	3.5	2	7221 B	10600	10500	2600	3600	78.5	117	178	2	4.40
	190	36	3.5	2	7221 C	12700	12900	5000	6700	37.7	117	178	2	3.75
	225	49	4	2	7321 A	16300	18000	2600	3600	72.5	119	211	2.5	9.40
225	49	4	2	7321 B	14900	16100	2400	3200	93.5	119	211	2.5	9.40	
225	49	4	2	7321 C	17500	19800	4300	6000	46.6	119	211	2.5	8.05	
110	170	28	3	1.5	7022 A	7550	8100	3200	4300	54.4	120	160	2	2.29
	170	28	3	1.5	7022 B	6800	7200	2800	3800	72.7	120	160	2	2.29
	170	28	3	1.5	7022 C	8300	8950	5000	7100	32.7	120	160	2	1.95
	200	38	3.5	2	7222 A	12700	13100	2800	3800	64.0	122	188	2	5.15
	200	38	3.5	2	7222 B	11500	11700	2600	3400	83.9	122	188	2	5.15
	200	38	3.5	2	7222 C	13800	14400	4500	6300	39.8	122	188	2	4.40
	240	50	4	2	7322 A	17300	19600	2400	3400	75.9	124	226	2.5	11.1
240	50	4	2	7322 B	15800	17600	2200	3000	98.0	124	226	2.5	11.1	
240	50	4	2	7322 C	18600	21600	4000	5600	48.4	124	226	2.5	9.50	
120	180	28	3	1.5	7024 A	8000	9000	3000	4000	57.3	130	170	2	2.46
	180	28	3	1.5	7024 B	7150	8000	2600	3600	76.9	130	170	2	2.46
	215	40	3.5	2	7224 A	14300	15700	2600	3400	68.4	132	203	2	6.20
	215	40	3.5	2	7224 B	13000	14000	2400	3200	90.3	132	203	2	6.20
	260	55	4	2	7324 A	19300	23000	2200	3000	82.3	134	246	2.5	14.3
260	55	4	2	7324 B	17700	20600	2000	2800	107.2	134	246	2.5	14.3	

双列滾珠軸承

内径 10~75mm

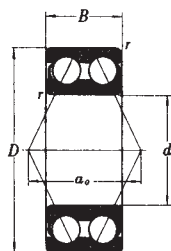

主要寸法(mm)				基本型號	基本定格荷重(kgf)		極限速率(rpm)	
d	D	B	r		C	Co	脂潤滑	油潤滑
10	30	14.3	1	5200	545	345	14000	19000
12	32	15.9	1	5201	715	465	13000	17000
15	35	15.9	1	5202	785	535	11000	15000
	42	19	1.5	5302	1130	775	9900	13000
17	40	17.5	1	5203	1000	700	9900	13000
	47	22.2	1.5	5303	1000	1160	9000	12000
20	47	20.6	1.5	5204	1540	1170	8800	12000
	52	22.2	2	5304	1930	1450	8000	11000
25	52	20.6	1.5	5205	1670	1330	7300	9800
	62	25.4	2	5305	2560	1980	6700	8900
30	62	23.8	1.5	5206	2320	1920	6300	8400
	72	30.2	2	5306	3200	2630	5700	7600
35	72	27	2	5207	3000	2620	5500	7400
	80	34.9	2.5	5307	4050	3400	5000	6600
40	80	30.2	2	5208	3450	3000	4900	6600
	90	36.5	2.5	5308	4950	4250	4400	5900
45	85	30.2	2	5209	3900	3450	4400	5900
	100	39.7	2.5	5309	5850	5150	4000	5300
50	90	30.2	2	5210	4150	3850	4000	5300
	110	44.4	3	5310	7450	6750	3600	4800
55	100	33.3	2.5	5211	5150	4900	3600	4900
	120	49.2	3	5311	8600	7950	3300	4400
60	110	36.5	2.5	5212	6200	6000	3400	4500
	130	54	3.5	5312	9800	9150	3000	4000
65	120	38.1	2.5	5213	6750	6650	3100	4200
70	125	39.7	2.5	5214	7350	7300	2900	3900
75	130	41.3	2.5	5215	7750	8050	2700	3600